



BERG GRAND ELITE

Productsheet XL



SPORTS
SERIES

BERG Grand Elite + Safety Net Deluxe, BERG Grand Elite InGround
+ Safety Net Deluxe, BERG Grand Elite InGround

*Superior quality
and safety*

BERGTOYS.COM



WHY A GRAND ELITE?

The very best trampoline

The BERG Elite has been developed with great attention and care. This resulted in a qualitative excellent trampoline, which is safe to use. It does not matter which one you choose, you choose quality with a BERG Elite. The BERG Elite is cleverly designed for long and safe jumping. The combination of the TwinSpring Gold springs and the AirFlow jumping technique ensures less air resistance, a larger jump area and more jumping fun! The protective edge is of extreme good quality.

In this productsheet you can find information about:

- The oval shape
- Less resistance with the BERG AirFlow jumping technique
- TwinSpring Gold springs for optimal jumping comfort
- Extra safe due to the thick PVC protective edge
- Galvanized and powder coated frame
- Available with Safety Net Deluxe

Warranty

Frame: 13 year*
Protective edge: 5 year
Jumping mat: 2 year
Springs: 5 year

* On registration at bergtoys.com/registration.



*Superior quality
and safety*

BERGTOYS.COM



1. THE OVAL SHAPE

The oval shape combines the efficient strength of a round frame with the large jumping surface of a rectangular trampoline. On an oval trampoline you can make some nice jumps over the entire length.

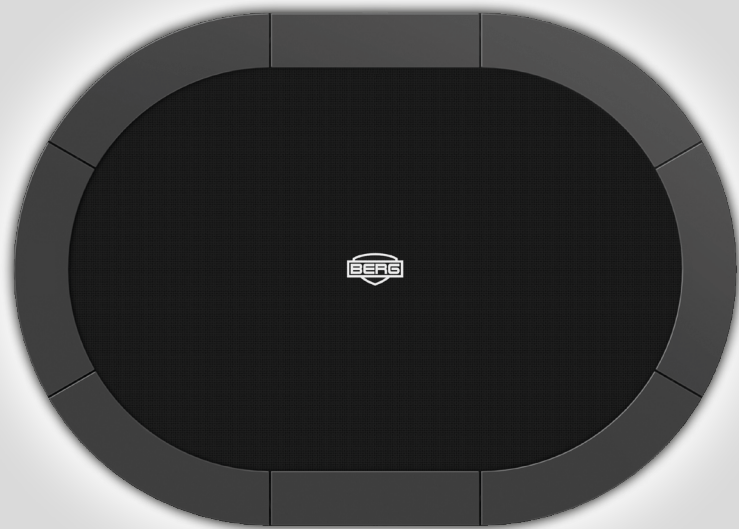

**BEST
OF
BOTH**

Strength



Ø 42 mm
Frame tubing
Elite 430



**Perfect
Jump Area**

Ø 48 mm
Frame tubing
Grand Elite 520



Ø 50,8 mm
Frame tubing
Ultim Eltim 330



2. PVC PROTECTIVE EDGE

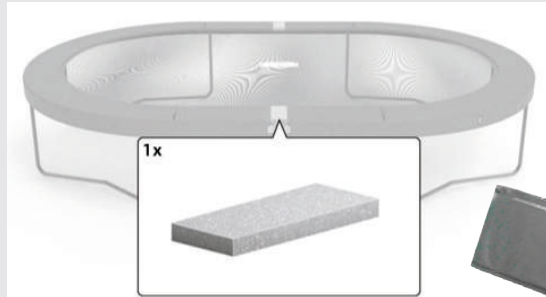

The center pieces of the padding consist of a long gapless design. The padding can be folded and fitted inside the packaging box when a small piece of foam is taken out. The piece of foam needs to go back into the padding during assembly. The gapless design has less wrinkles and a much smoother look.

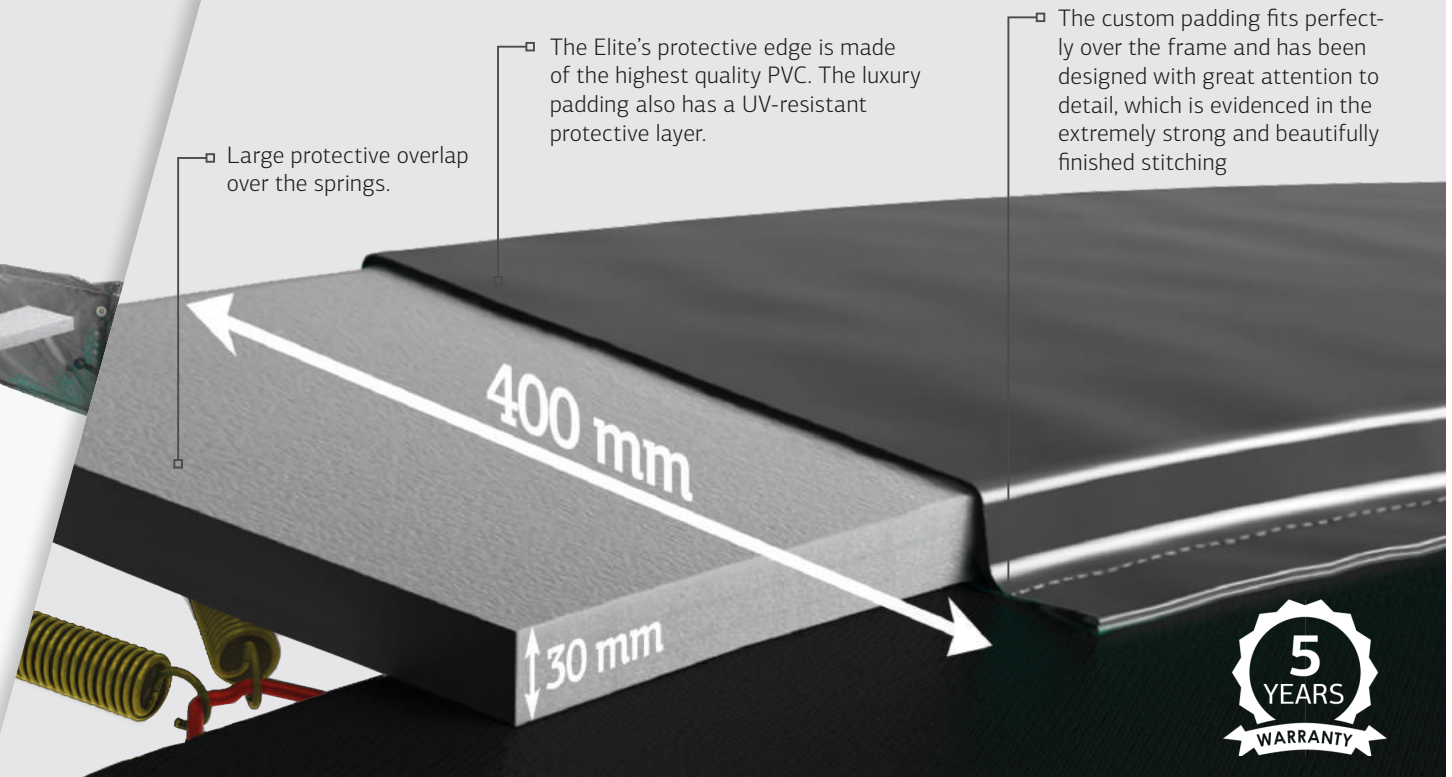

**Superior quality
and safety**



- The Elite padding has an extremely long lifespan which keeps its good looks 2-3 times longer than a Champion padding.
- The adhesion of the PVC material to the polyester mesh inside is up to 50% better than on the Champion padding. Because of this, the material is much less prone to delamination.
- The canvas is finished with a glossy coating to provide a luxurious appearance. The coating not only looks nice, but it has a purpose because of the UV-blockers it contains. The glossy surface finish reflects the light and UV instead of absorbing it, which makes the canvas better resistant to decoloration and degradation caused by the influence of UV light.
- The Elite padding fits super tight around the trampoline. This helps preventing wrinkles and always looks nice and tidy. The design of the padding has a much tighter fitting than the one on the Champion models. It takes almost twice as long as the Champion padding to sew the parts together to achieve the tight fitting. The tight fitting is achieved by first stitching the canvas segments together and then filling it with the foam parts by hand.
- The padding has an extra flange on the inner edge that is there to make sure the padding always lays flush with the jumping mat and to prevent gaps in between the jumping mat and the padding.

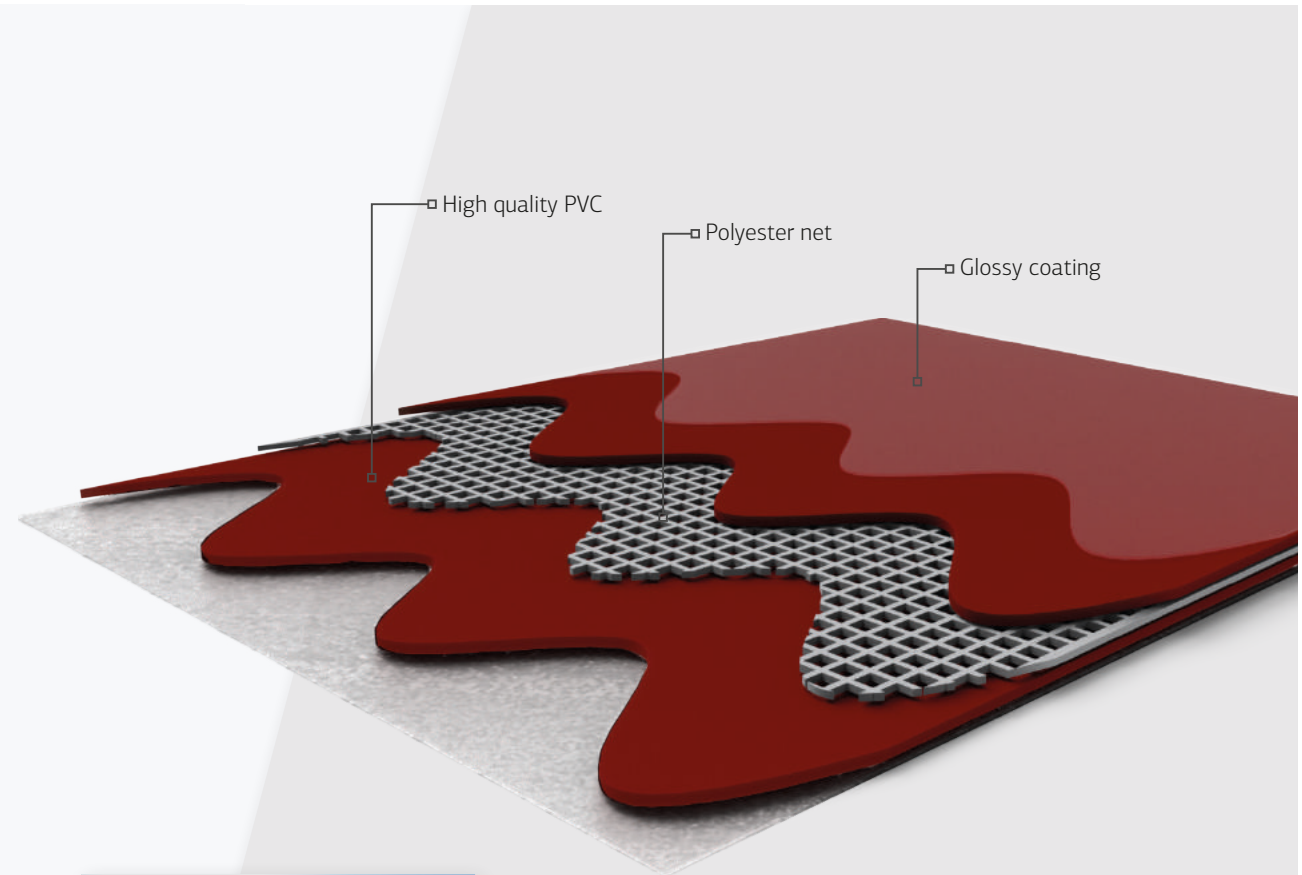

*Superior quality
and safety*



3. AIRFLOW

Higher jumps mean more fun. We have developed the AirFlow technique to enable you to make higher jumps. This jumping mat allows 50% more air permeation compared with a standard jumping mat. Good airflow ensures less resistance while jumping, which is why you can make higher jumps.

The durable AirFlow jump mat is made from woven polypropylene. The jump mat contains special spring-eyes for the TwinSpring system. The loops for the strong metal spring eyes are thoroughly joined to the jump mat with no less than 8 rows of stitching.

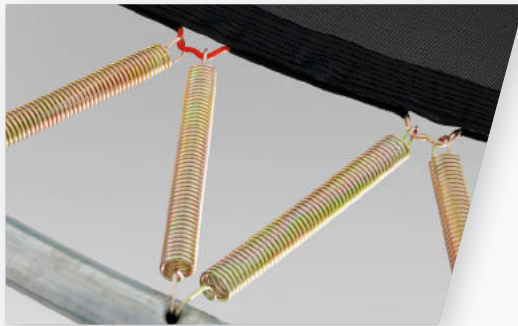

50% more air permeation for better jumping comfort

BERG
NEW
PRODUCT
INNOVATION

AIRFLOW
Higher & more flexible jumping

AIRFLOW

The AirFlow product innovation is only available on the BERG Champion and BERG Elite lines.

*Superior quality
and safety*

BERGTOYS.COM



4. TWINSRING GOLD

The perfect jump area is that optimal part of the jump mat which results in the best jump experience. Jumping outside of this area results in a sense of feeling as if you are being pushed towards the inner part of the trampoline. Trampolines comprising of TwinSpring Gold Springs are mounted in the shape of a "V". This allows for larger perfect jump area compared to trampolines that are sold with a conventional spring.

Another advantage? Due to the angled positioning of the TwinSpring Gold, the springs are longer in length without compromising the size of the jump mat. This results in a safer trampoline that optimizes playing pleasure!

TwinSpring Gold



Perfect Jump Area

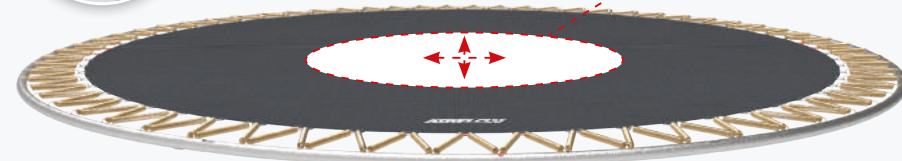

GoldSpring Solo



Perfect Jump Area

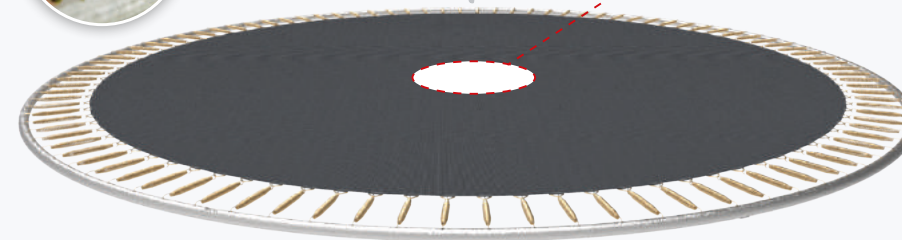

*Superior quality
and safety*



5. FRAME

The frame of the Elite trampolines has a very long lifespan. This is due to the large tube diameter of 42 mm and the wall thickness of 2 mm. In addition, the frame has a solid zinc layer and the legs of the Regular trampolines even have a protective black powder coat. The frame is therefore extra rust resistant.

Original design

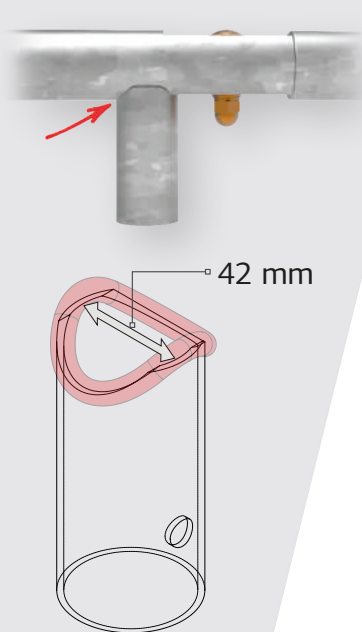

Improved design!



Applicable on all Grand Elite models
except for the Grand Elite 350

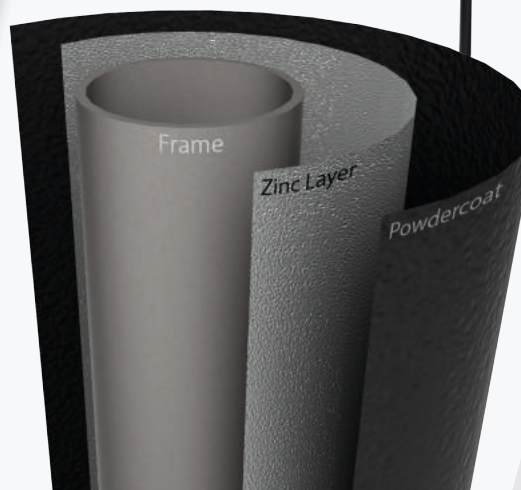

*Superior quality
and safety*



6. SAFETY NET DELUXE



Safety Net is extra safe and user friendly by allowing space between the edge of the netting and the edge of the trampoline.



Superior quality and safety



BERG GRAND ELITE + SAFETY NET DELUXE

The very best trampoline

BERG Trampoline ●

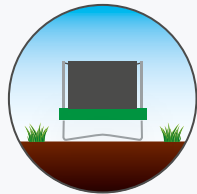

If you prefer not to dig a hole in your garden, a high trampoline is a good choice. A high trampoline is easy to install and move around. A high trampoline is also clearly visible in your garden.



Article number	EAN - Code	Product name	Package 1	Package 2	Package 3	Number of springs	Entrance height in cm	Testweight in kg	Max user-weight in kg	Tube diameter / wall thickness toprail in mm	Tube diameter / wall thickness legs in mm	Tube diameter / wall thickness Safety Net poles in mm	Padding thickness in mm	Width padding in mm	Total height trampoline in cm
30.45.75.30	8715839067859	BERG Grand Elite 520 Grey + Safety Net Deluxe	30.99.15.90	30.45.15.30	35.72.63.01	144	95	600	120	Ø48x2,0	Ø42x2	38,1 x 1,5	30	400	275

*Superior quality
and safety*

BERGTOYS.COM



BERG GRAND ELITE INGROUND + SAFETY NET DELUXE

The very best trampoline

BERG InGround Trampoline ●

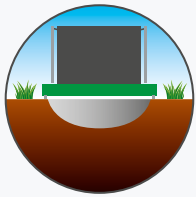

A sunken trampoline with a safety net has a low threshold, making it easy and safe to step onto. The InGround trampoline is less visible in the garden than a high trampoline.



Article number	EAN - Code	Product name	Package 1	Package 2	Package 3	Number of springs	Entrance height in cm	Testweight in kg	Max userweight in kg	Tube diameter / wall thickness toprail in mm	Tube diameter / wall thickness legs in mm	Tube diameter / wall thickness Safety Net poles in mm	Padding thickness in mm	Width padding in mm	Total height trampoline in cm
30.43.75.30	8715839067842	BERG Grand Elite InGround 520 Grey + Safety Net Deluxe	30.99.15.90	30.43.15.30	35.72.63.01	144	27	600	120	Ø48x2,0	Ø42x2	38,1 x 1,5	30	400	207

Superior quality and safety

BERGTOYS.COM



BERG GRAND ELITE INGROUND

The very best trampoline

BERG InGround Trampoline ●

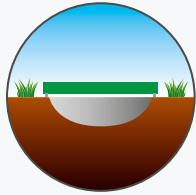

The sunken trampoline without safety net (sports) is nicely concealed in your garden. The low threshold of 20 centimetres makes the trampoline easy and safe to step onto.



Article number	EAN - Code	Product name	Package 1	Package 2	Package 3	Number of springs	Entrance height in cm	Testweight in kg	Max userweight in kg	Tube diameter / wall thickness top rail in mm	Tube diameter / wall thickness legs in mm	Padding thickness in mm	Width padding in mm	Total height trampoline in cm
30.43.25.30	8715839067835	BERG Grand Elite InGround 520 Grey	30.99.15.90	30.43.15.30	-	144	27	600	120	Ø48x2,0	Ø42x2	30	400	27

*Superior quality
and **safety***

BERGTOYS.COM



BERG GRAND ELITE ACCESSORIES

The very best trampoline

Accessory	Article	Product weight	Product weight + box	Box size in cm
1 BERG Grand weather cover Extra Grey	35.99.68.00	8.35 kg	9.36 kg	42x21x57

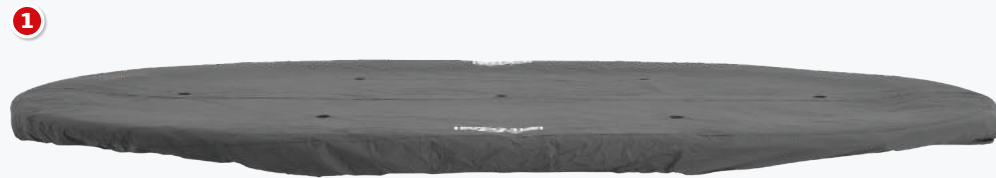

*Superior quality
and **safety***





BERG GRAND ELITE ACCESSORIES

The very best trampoline

Accessory	Article	Product weight	Product weight + box	Box size in cm
1 BERG Ladder L	35.90.04.00	2.7 kg	3.4 kg	84x6x24
2 BERG Ladder Platform + Ladder L	35.90.54.00	5.5 kg	7.3 kg	56x14x54 + 24x84x6
3 BERG Anchor set	35.99.10.00	1.41 kg	1.5 kg	30x10x10



Ladder L
For trampolines measuring 85, 90 and 95 cm high. The ladder is height adjustable.



**Superior quality
and safety**





BERGTOYS.COM